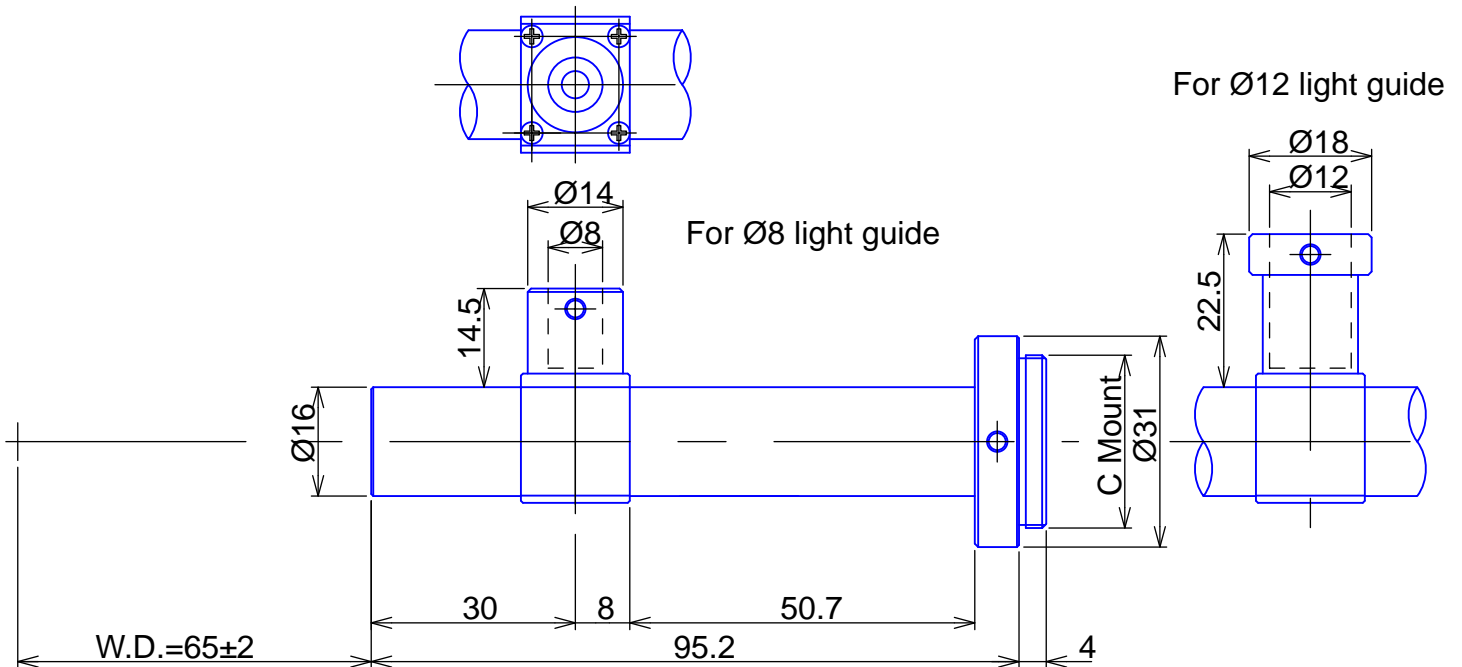

Fixed Magnification Lens 65mm(W.D.) 1/2" Format

Item No.1D-65

ITEM NO.		1D-65	
MAGNIFICATION		x1.00	
W.D.		65.0	(mm)
APERTURE		F14.2	
DEPTH OF FIELD		1140	(um)
OBJECT SIZE		-	(mm)
IMAGE SIZE		-	(mm)
RESOLUTION POWER		9.6	(um)
NA		0.035	
TV DISTORTION		0.11	(%)
FIELD OF VIEW	1/2"	4.8 x 6.4	(mm)
	1/3"	3.6 x 4.8	(mm)
	1/4"	2.7 x 3.6	(mm)
NOTES		Coaxial	

GOYO OPTICAL Inc.,

3-8-31 HAMASAKI, ASAKA, SAITAMA 351-0033, JAPAN,
 TEL:+81-48-474-2235 FAX:+81-48-474-7373
<http://www.gyooptical.com> E-MAIL:info@gyooptical.com