

## 1-3 Megapixel High Resolution Lenses

Item No.	F Length	Iris Range	Angle of View ( H x V x D )		M.O.D	Filter Thread	Dimention (DxL)	Weight
			1/2"	2/3"				
GMTHR23514MCN	3.5mm	F1.4-16	103°34'x76°54'x131°4'		0.2m		Ø31 x 31.75mm	100g
GNTHR24514MCN	4.5mm	F1.4-16	78°96'x59°41'x98°23'		0.2m		Ø31 x 29.5mm	100g
GMHR26012MCN	6.0mm	F1.2-16.0	56°2'x43°5'x67°0'		0.1m	M30.5, P0.5	Ø34 x 46mm	110g
GMHR26014MCN	6.0mm	F1.4-16.0	57°4'x44°3'x72°9'		0.2m	M30.5, P0.5	Ø32 x 37.5mm	70g
GMTHR21614MCN	16.0mm	F1.4-16.0	Ø8.8, 24°x18°x29°7'		0.3m	M25.5, P0.5	Ø29 x 31.5mm	50g
GMTHR36014MCN	6mm	F1.4-16		82°x61°3'x103°02'	0.1m		Ø30 x 32.8mm	100g
GMHR38014MCN-1	8mm	F1.4-16		56°6'x43°95'x67°22'	0.1m	M27, P0.5	Ø31 x 41mm	100g
GMTHR38014MCN	8.25mm	F1.44-16		57°32'x44°29'x68°66'	0.1m	M27.0, P0.5	Ø30 x 47.5mm	85g
GMXHR38014MCN	8.0mm	F1.4-22		56°7'x43°8'x68°2'	0.1m	M35.5, P0.5	Ø37.5 x 28mm	80g
GMHR31214MCN-1	12.0mm	F1.4-16		38°25'x29°14'x46°71'	0.15m	M27.0, P0.5	Ø31 x 37mm	100g
GMTHR31214MCN	12.3mm	F1.45-16		39°59'x30°17'x48°38'	0.1m	M27.0, P0.5	Ø30 x 47.5mm	90g
GMXHR31218MCN-1	12mm	F1.8 - 22		40°3'x30°8'x49°3'	0.15m	M35.5, P0.5	Ø37.5 x 56.5mm	170g
GMHR31614MCN-1	16mm	F1.4-16		30°3'x16°05'x37°33'	0.2m	M27, P0.5	Ø33 x 36.5mm	100g
GMTHR31614MCN	16.2mm	F1.45-16		30°46'x23°07'x37°55'	0.1m	M27.0, P0.5	Ø30 x 42.5mm	80g
GMXHR31614MCN-1	16.0mm	F1.4-22		30°75'x23°31'x37°8'	0.2m	M35.5, P0.5	Ø37.5 x 60.5mm	175g
GMHR32514MCN-1	25mm	F1.4-16		19°57'x14°75'x24°3'	0.2m	M27.0, P0.5	Ø33 x 39.5mm	100g
GMTHR32514MCN	25.0mm	F1.4-16.0	14°6'x11°0'x18°2'	20°1'x15°1'x25°0'	0.25m	M25.5, P0.5	Ø29 x 32.0mm	50g
GMXHR32514MCN	25.0mm	F1.4-22		20°0'x15°0'x24°8'	0.2m	M35.5, P0.5	Ø37.5 x 44.5mm	110g
GMHR33520MCN-1	35mm	F2-Close		14°3'x10°5'x17°8'	0.3m	M25.5, P0.5	Ø34 x 36mm	95g
GMTHR33520MCN	35.0mm	F2.0-22.0	10°5'x7°9'x13°1'	14°3'x10°5'x17°8'	0.25m	M25.5, P0.5	Ø29 x 47mm	-g
GMXHR33514MCN-1	35.0mm	F1.4-22		14°3'x10°8'x17°8'	0.25m	M35.5, P0.5	Ø37.5 x 56.5mm	145g
GMHR35028MCN-1	50mm	F2.8-Close		10°x7°5'	0.5m	M25.5, P0.5	Ø29 x 47mm	-g
GMTHR35028MCN	50.0mm	F2.8-22	7°3'x5°5'x9°0'	10°0'x7°5'x12°4'	0.5m	M25.5, P0.75	Ø29 x 39.0mm	95g

GMTHR23514MCN

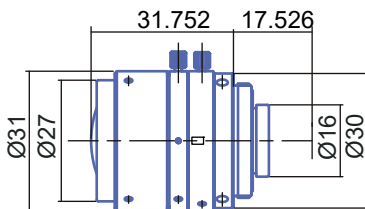

GMTHR24514MCN

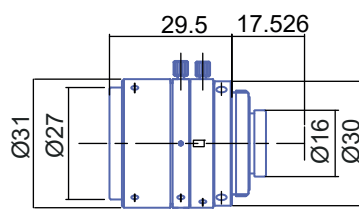

GMTHR36014MCN

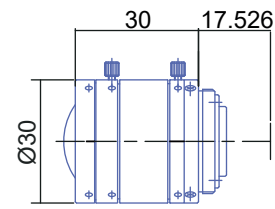

GMHR38014MCN-1

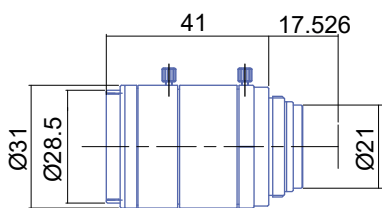

GMHR31214MCN-1

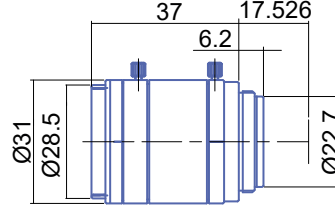

GMHR31614MCN-1

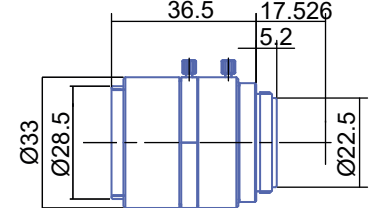

GMHR32514MCN-1

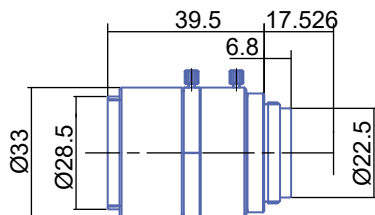

GMTHR33520MCN-1

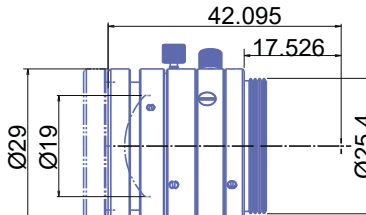

GMTHR35028MCN-1

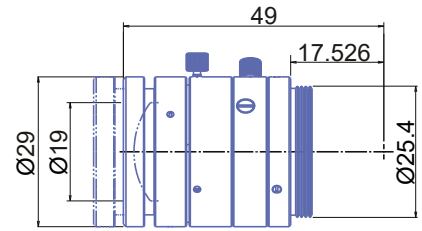

\*Specifications are subject to change without prior notice

## 3-5 Megapixel 1Inch Format High Resolution Lenses

Item No.	F Length	Iris Range	Angle of View (H x V x D)	M.O.D	Filter Thread	Dimension(DxL)	Weight
GMTHR46018MCN	6mm	F1.8-22	1" 95°1'x78°7'x104°6'	0.1m	No	Ø54x50.3mm	225g
GMTHR48014MCN	8mm	F1.4-16	1" 79°66'x62°92'x92°4'	0.1m	M55, P0.75	Ø57 x 58.59mm	225g
GMTHR48014MCN-1	8mm	F1.4-22	1" 79°7'x62°9'x92°6'	0.1m	M55, P0.75	Ø57 x 58mm	220g
GMTHR412514MCN	12.5mm	F1.4-16	1" 56°45'x42°51'x67°59'	0.1m	M35.5, P0.5	Ø43 x 52.94mm	200g
GMTHR412514MCN-1	12.5mm	F1.4-22	1" 55°7'x42°7'x67°8'	0.3m	M35.5, P0.5	Ø40 x 52mm	160g
GMTHR41614MCN	16mm	F1.4-22	1" 44°5'x33°8'x54°6'	0.3m	M35.5, P0.5	Ø40 x 42mm	225g
GMTHR42514MCN	25mm	F1.4-22	1" 29°x21°9'x36°1'	0.3m	M35.5, P0.5	Ø40 x 42.5mm	225g
GMTHR43514MCN	35mm	F1.4-22	1" 10°4'x15°7'x26°	0.3m	M35.5, P0.5	Ø40 x 42.5mm	225g
GMTHR45014MCN	50mm	F1.4-16	1" 14°5'x10°92'x18°03'	0.5m	M40.5, P0.5	Ø47.5 x 48mm	225g
GMHR47518MCN	75mm	F1.8-16	1" 9°7'x7°3'x12°0'	1.0m	M46.0, P0.75	Ø49 x 57mm	180g

GMTHR46018MCN

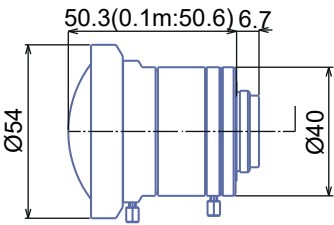

GMTHR48014MCN

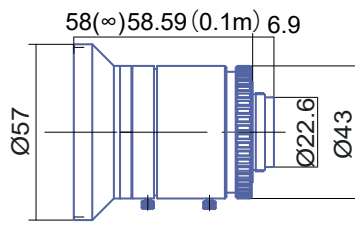

GMTHR412514MCN

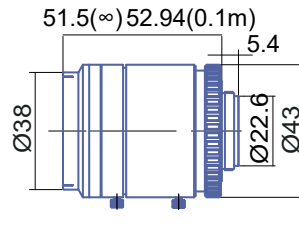

GMTHR45014MCN

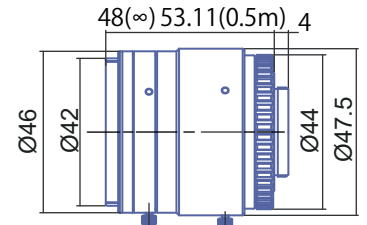

GMTHR48014MCN-1

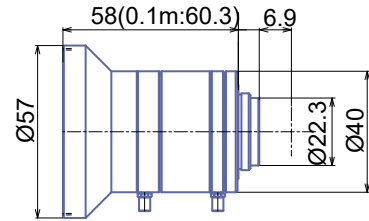

GMTHR41614MCN

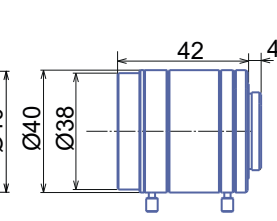

GMTHR42514MCN

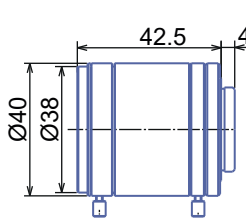

GMTHR43514MCN

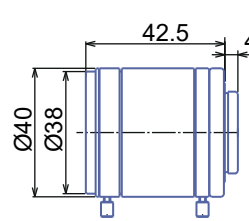

GMTHR412514MCN-1

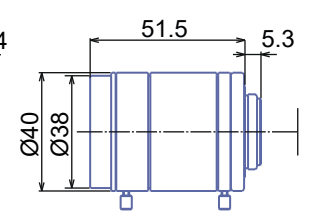

## 5Megapixel High Resolution Lenses

Item No.	F Length	Iris Range	Angle of View (HxVxD)	M.O.D	Filter Thread	Dimension (DxL)	Weight
GMR5HR181214MCN	12 mm	F1.4-22	1/1.8" 32°38'x24°58'x39°79'	0.2m	M27, P0.5	Ø29.5 x 35.7mm	57g
GMA5HR38028MCN	8 mm	F2.8-22	2/3" 57°9'x45°0'	0.1m	M49.0, P0.75	Ø51 x 48.5mm	210g
GMA5HR31218MCN	12mm	F1.8-22	2/3" 40°3'x30°8'	0.15m	M49, P0.75	Ø51 x 59.0mm	200g
GMR5HR31614MCN	16 mm	F1.4-16	2/3" 30°99'x23°43'x38°29'	0.25m	M27, P0.5	Ø29.5 x 37.2mm	64g
GM5HR31614MCN	16 mm	F1.4-22	2/3" 30°7'x23°3'	0.2m	M49, P0.75	Ø51 x 62.5mm	200g
GMR5HR32514MCN	25 mm	F1.4-16	2/3" 19°98'x15°04'x24°86'	0.25m	M27, P0.5	Ø29.5 x 38.8mm	56g
GM5HR32514MCN	25 mm	F1.4-22	2/3" 20°0'x15°0'	0.2m	M49, P0.75	Ø51 x 48.0mm	190g
GMB5HR32514MCN	25 mm	F1.4-16	2/3" 19°6'x14°8'x24°3'	0.2m	M30.5, P0.5	Ø38.5 x 44.0mm	90g
GMR5HR33516MCN	35 mm	F1.6-16	2/3" 14°74'x11°08'x18°37'	0.35m	M27, P0.5	Ø29.5 x 40.8mm	65g
GM5HR33514MCN	35 mm	F1.4-22	2/3" 10°4'x7°8'	0.25m	M49, P0.75	Ø51 x 62.0mm	230g
GMR5HR35028MCN	50 mm	F2.8-22	2/3" 10°03'x7°54'x12°52'	0.8m	M27, P0.5	Ø29.5 x 38mm	55g
GMB5HR35028MCN	50 mm	F2.8-22	2/3" 9°6'x7°2'x11°9'	0.2m	M30.5, P0.5	Ø38.5 x 76.0mm	120g
GM5HR128024MCN	8 mm	F2.4-16	1/1.2" 70°3'x54°9'(4:3)	0.1m	M35.5, P0.5	Ø37 x 43mm	90g
GM5HR121220MCN	12mm	F2-16	1/1.2" 49°2'x37°6'(4:3)	0.1m	M27, P0.5	Ø29 x 39mm	70g
GM5HR121620MCN	16 mm	F2-16	1/1.2" 37°4'x28°4'(4:3)	0.1m	M27, P0.5	Ø29 x 32mm	60g
GM5HR122518MCN	25 mm	F1.8-16	1/1.2" 24°1'x18°2'(4:3)	0.1m	M27, P0.5	Ø29 x 37mm	60g
GM5HR123521MCN	35 mm	F2.1-16	1/1.2" 17°3'x13°1'(4:3)	0.2m	M27, P0.5	Ø29 x 40mm	60g
GM5HR125028MCN	50 mm	F2.8-16	1/1.2" 12°2'x9°2'(4:3)	0.3m	M27, P0.5	Ø29 x 52mm	75g
GM5HR127535MCN	75 mm	F3.5-16	1/1.2" 8°1'x6°1'(4:3)	0.7m	M27, P0.5	Ø29 x 65mm	90g

## 6-8 Megapixel High Resolution Lenses

Item No.	F Length	Iris Range	Angle of View ( H x V x D )	M.O.D	Filter Thread	Dimension(DxL)	Weight
GM6HR38014MCN	8mm	F1.4-16	2/3" 56°6'x43°95'x67°22'	0.1m	M27, P0.5	Ø31x41mm	100g
GM6HR31214MCN	12mm	F1.4-16	2/3" 38°25'x29°14'x46°71'	0.15m	M27, P0.5	Ø31x37mm	100g
GM6HR31614MCN	16mm	F1.4-16	2/3" 30°3'x16°05'x37°33'	0.2m	M27, P0.5	Ø33x36.5mm	100g
GM6HR32514MCN	25mm	F1.4-16	2/3" 19°57'x14°75'x24°3'	0.2m	M27, P0.5	Ø33x39.5mm	100g
GM8MPDN41450MCN	14-50mm	F2.6-16	1" 50°5'x38.0' - 14°5'x11°1'	1.2m	M58, P0.75	Ø60x90mm	400g

GM6HR38014MCN

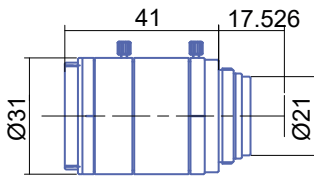

GM6HR31214MCN

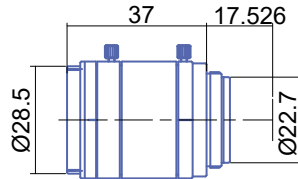

GM6HR31614MCN

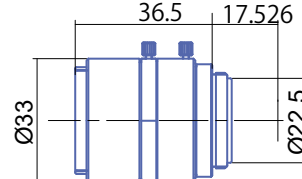

GM6HR32514MCN

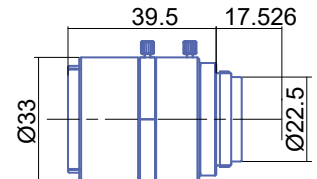

## 12Megapixel High Resolution Lenses

Item No.	F Length	Iris Range	Angle of View ( H x V x D )	M.O.D	Filter Thread	Dimension(DxL)	Weight
GM12HR62520MCN	25mm	F2.0-22	4/3" 40°6'x31°	0.15m	M46.0, P0.75	Ø48 x 82.7mm	250g
GM12HR63520MCN	35mm	F2.0-22	4/3" 29°6'x22°4'	0.2m	M40.5, P0.5	Ø44.6 x 54.9mm	173g
GM12HR65020MCN	50mm	F2.0-22	4/3" 20°9'x15°7'	0.3m	M40.5, P0.5	Ø44.6 x 53.7mm	170g
GM12HR58018MCN	8mm	F1.8-22	1.1" 83°5'x66°7'	0.3m	M77, P0.75	Ø80 x 96.8mm	500g
GM12HR51618MCN	16mm	F1.8-16	1.1" 41°85'x41°85'	0.05m	M49, P0.75	Ø51 x 91.5mm	300g
GM12HR52514MCN	25mm	F1.8-16	1.1" 27°06'x27°06'	0.08m	M52, P0.75	Ø55 x 74.5mm	300g
GM12HR53514MCN	35mm	F1.8-16	1.1" 19°30'x19°30'	0.11m	M46, P0.75	Ø51 x 67.5mm	300g
GM12HR55018MCN	50mm	F1.8-16	1.1" 14°x14°	0.2m	M49, P0.75	Ø51 x 74.5mm	300g
GM12HR57518MCN	75mm	F1.8-16	1.1" 9°35'x9°35'	0.3m	M55, P0.75	Ø57.5 x 116.5mm	300g
GM12HR41216MCN	12mm	F1.6-22	1" 57°1'x44°1'	0.2m	M52, P0.75	Ø54 x 61mm	190g
GM12HR41616MCN	16mm	F1.6-22	1" 44°2'x33°5'	0.35m	M37.5, P0.5	Ø47.5 x 58mm	205g
GM12HR42016MCN	20mm	F1.6-22	1" 36°1'x27°2'	0.45m	M39, P0.5	Ø43 x 55mm	165g
GM12HR42516MCN	25mm	F1.6-22	1" 29°x21°8'	0.45m	M39, P0.5	Ø43 x 52mm	160g
GM12HR43514MCN	35mm	F1.6-22	1" 20°7'x51°6'	0.45m	M39, P0.5	Ø43 x 49mm	155g
GM12HR30528MCN	5mm	F1.8-22	2/3" 81°54'x65°76'	0.1m	M55, P0.75	Ø57 x 64.5mm	300g
GM12HR38018MCN	8mm	F1.8-22	2/3" 57°45'x44°50'	0.1m	M40.5, P0.5	Ø47.5 x 73.2mm	300g
GM12HR38016MCN	8mm	F1.6-22	2/3" 55°8'x43°3'	0.15m	M40.5, P0.5	Ø45 x 53mm	170g
GM12HR39014MCN-1	9mm	F1.4-Close	2/3" 50°8'x39°3'	0.1m	M46.0, P0.75	Ø48 x 54mm	160g
GM12HR31214MCN	12mm	F1.4-22	2/3" 39°75'x30°35'	0.1m	M37.5, P0.75	Ø44.5 x 62mm	300g
GM12HR31216MCN	12mm	F1.6-22	2/3" 39°8'x30°4' 1/2" 38°2'x29°1'	0.1m	M37.5, P0.5	Ø43.2 x 58.5mm	178g
GM12HR312514MCN-1	12.5mm	F1.4-Close	2/3" 37°8'x28°8"	0.15m	M46.0, P0.75	Ø48 x 66.8mm	205g
GM12HR31616MCN	16mm	F1.6-22	2/3" 30°8'x23°4' 1/2" 28°x21°2"	0.2m	M37.5, P0.5	Ø43.2 x 63.3mm	181g
GM12HR31814MCN-1	18mm	F1.4-Close	2/3" 27°8'x21°	0.2m	M46.0, P0.75	Ø48 x 73.5mm	285g
GM12HR32514MCN	25mm	F1.4-22	2/3" 20°x15° 1/2" 20°4'x15°4'	0.2m	M37.5, P0.5	Ø43.2 x 54.5mm	148g
GM12HR33514MCN	35mm	F1.4-22	2/3" 14°3'x10°8'	0.3m	M37.5, P0.5	Ø43.2 x 56.8mm	156g
GM12HR35018MCN	50mm	F1.8-22	2/3" 10°1'x7°6'x12°6'	0.4m	M37.5, P0.5	Ø43.2 x 58.5mm	173g
GM12HR37520MCN	75mm	F2.0-22	2/3" 6°7'x5°x8°4'	0.9m	M37.5, P0.5	Ø45 x 71.7mm	223g

\*Specifications are subject to change without prior notice

## 12Megapixel High Resolution Lenses

GM12HR62520MCN

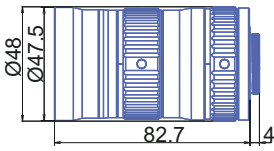

GM12HR63520MCN

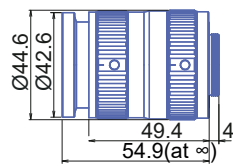

GM12HR65020MCN

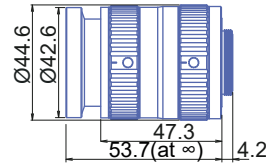

GM12HR58018MCN

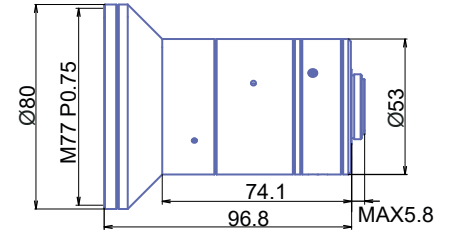

GM12HR551618MCN

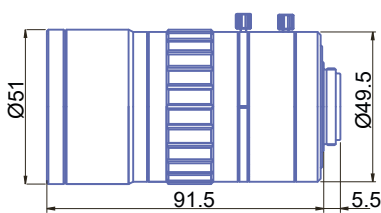

GM12HR52514MCN

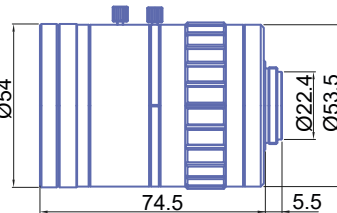

GM12HR53514MCN

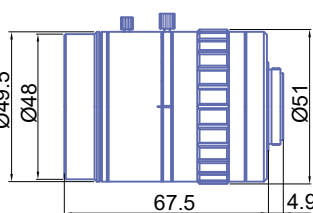

GM12HR55018MCN

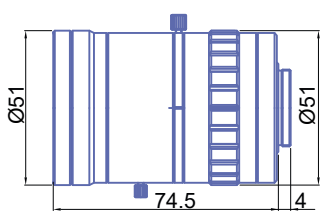

GM12HR57518MCN

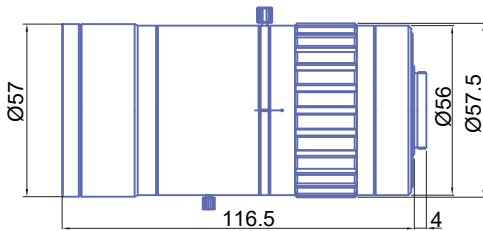

GM12HR41216MCN

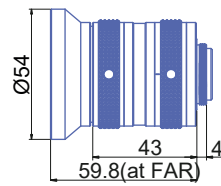

GM12HR41616MCN

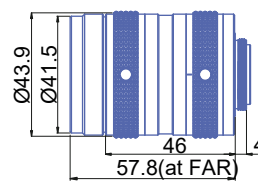

GM12HR42016MCN

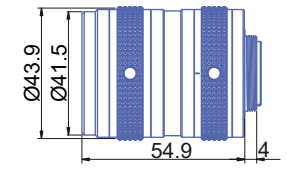

GM12HR42516MCN

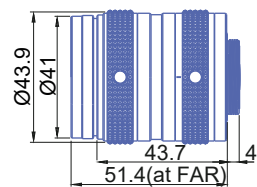

GM12HR43514MCN

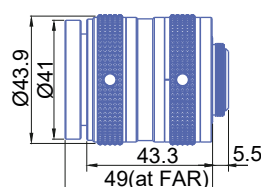

GM12HR30528MCN

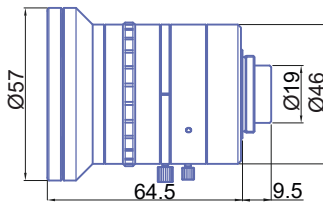

GM12HR38018MCN

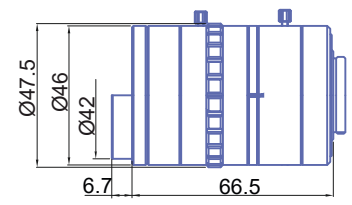

GM12HR31214MCN

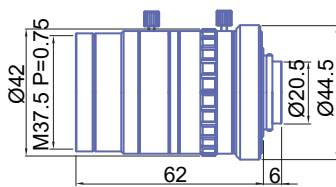

GM12HR312514MCN-1

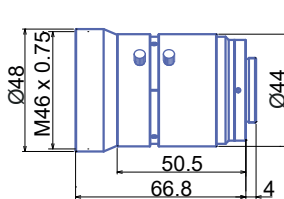

GM12HR39014MCN-1

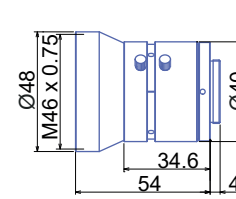

GM12HR31814MCN-1

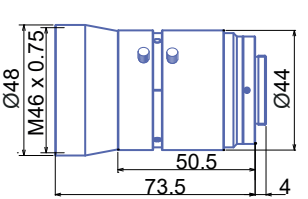

GM12HR32514MCN

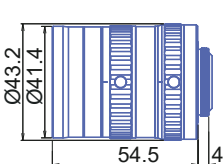

GM12HR33514MCN

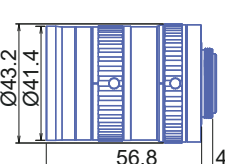

GM12HR31616MCN

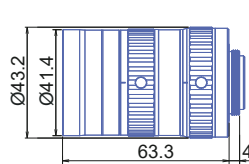

GM12HR35018MCN

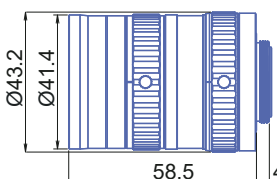

GM12HR37520MCN

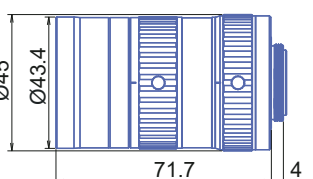

\*Specifications are subject to change without prior notice

## 1-3 Megapixel High Resolution Varifocal zoom Lenses

Item No.	F Length	Iris Range	Angle of View (HxVxD)	M.O.D	FilterThread	Dimension (DxL)	Weight
GMMPZ4411MCN	4.4-11 mm	F1.6-16	1/1.8" 36°7'x28°0'x44°8' - 76°6'x61°2'x89°4'	0.3m	M43 , P0.75	Ø45 x 56.5mm	125g
GMMPZ1664MCN	16-64 mm	F1.8-16	1" 11°7'x8°8'x14°6' - 45°9'x34°2'x57°9'	1.0m	M58 , P0.75	Ø60 x 125mm	375g

## Megapixel Three Motorized Zoom Lenses

Item No.	F Length	Iris Range	Angle of View (HxVxD)	M.O.D	FilterThread	Dimension (DxL)	Weight
GAZMPDN42465M	24-65 mm	F2-Close	1" 30°5'x22°9'x38°1' - 11°2'x8°4'x13°8'	7m	M62 , P0.75	Ø80 x 80.5 x 112.5mm	1710g
GAZMP31166M	11-66 mm	F1.8-Close	2/3" 43°3'x33°0' - 7°7'x5°8'	1.4m	M72 , P0.75	Ø85 x 84.5 x 110mm	700g
GAZMP310100M	10-100 mm	F1.4-Close	2/3" 47°5'x36°5' - 5°0'x3°8'	1.2m	M62 , P0.75	Ø80 x 70 x 125mm	700g
GAZMP280136M	8-136 mm	F1.6-Close	2/3" 43°6'x33°4' - 2°7'x2°2'	1.8m	M58, P0.75	Ø79 x 72.5 x 130mm	650g
GAZMPDN280800M	8-80 mm	F1.6-Close	2/3" 46°6'x34°3' - 4°7'x3°6'	0.1m	M52 , P0.75	Ø83.5 x 81.5 x 91.5mm	600g

**GAZMPDN42465M**

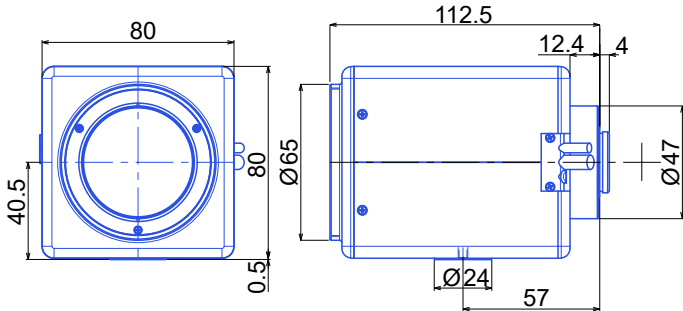

**GAZMP31166M**

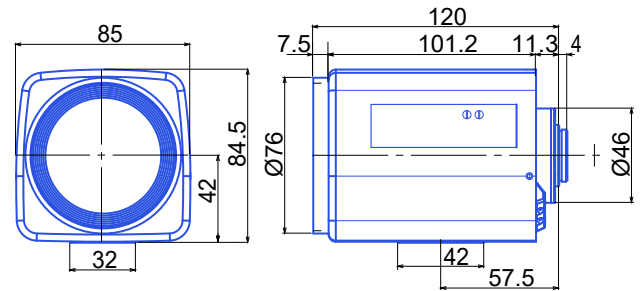

**GAZMP280136M**

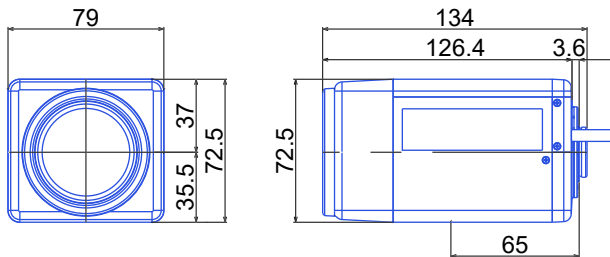

**GAZMPDN280800M**

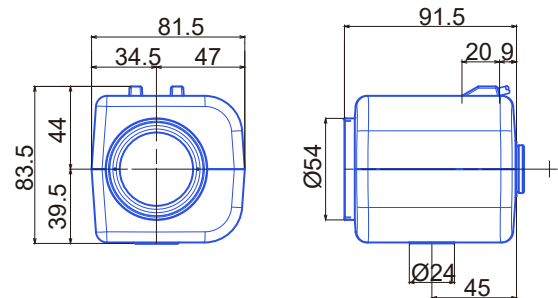

**GAZMP30100M**

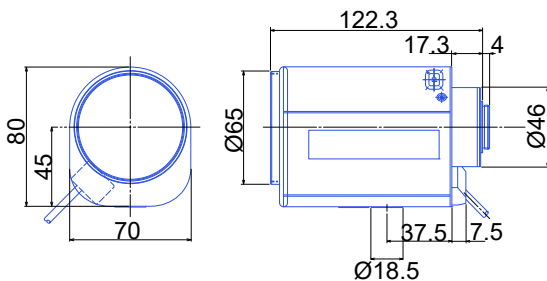

\*Specifications are subject to change without prior notice

## Standard Manual Lenses

Item No.	F Length	Iris Range	Angle of View (H x V x D)		M.O.D	Filter Thread	Dimension (DxL)	Weight
			1/2"	2/3"				
GM23514MCN	3.5mm	F1.4-Close	103°6'x76°0'x132°1'		0.2m		Ø31 x 30.5mm	73g
GM23516MCN	3.5mm	F1.6-Close	84°9'x68°9'x97°6'		0.1m	M43.0 , P0.75	Ø45 x 37.5mm	90g
GM24514MCN	4.5mm	F1.4-Close	79°0'x59°4'x98°2'		0.2m		Ø31 x 29.5mm	71g
GM26014MCN	6.0mm	F1.4-Close	54°35'x42°19'x65°39'		0.2m	M27.0 , P0.5	Ø30 x 30.0mm	57g
GMN36014MCN-1	6.0mm	F1.4-16	59°4'x44°5'x74°3'	81°9'x61°2'x102°9'	0.1m		Ø30 x 33.0mm	65g
GM38013MCN-1	8.0mm	F1.3-Close	42°0'x32°7'x50°3'		0.2m	M25.5 , P0.5	Ø30 x 34.5mm	60g
GMN38014MCN-1	8.0mm	F1.4-16	46°2'x34°6'x58°1'		0.1m	M27.0 , P0.5	Ø30 x 30.0mm	55g
GM21214MCN	12.0mm	F1.4-Close	28°58'x21°56'x35°49'		0.3m	M27.0 , P0.5	Ø30 x 34.5mm	56g
GMN31214MCN-1	12.0mm	F1.4-16	30°7'x23°0'x38°5'		0.1m	M27.0 , P0.5	Ø30 x 31.5mm	55g
GM31614MCN	16.0mm	F1.4-Close	22°2'x16°5'x27°58'		0.4m	M27.0 , P0.5	Ø30 x 24.5mm	40g
GMN31614MCN-1	16.0mm	F1.4-16	22°2'x16°5'x27°5"		0.2m	M27.0 , P0.5	Ø30 x 28.0mm	40g
GM32514MCN	25.0mm	F1.4-Close	14°3'x10°5'x18°11'		0.5m	M27.0 , P0.5	Ø30 x 24.5mm	40g
GMN32516MCN-1	25.0mm	F1.6-16	15°3'x11°4'x19°1'		0.2m	M27.0 , P0.5	Ø30 x 28.5mm	50g
GM23512MCN	35.0mm	F1.2-Close	10°4'x7°8'x12°1'		1.0m	M40.5 , P0.5	Ø46 x 43.0mm	150g
GM33519MCN	35.0mm	F1.9-Close	10°5'x7°9'x13°1'		0.5m	M27.0 , P0.5	Ø30 x 28.0mm	50g
GMN33516MCN-1	35.0mm	F1.6-16	10°5'x7°9'x13°1'		0.35m	M30.5 , P0.5	Ø32 x 36.5mm	75g
GM35018MCN	50.0mm	F1.8-Close	7°4'x5°4'x9°3'		1.0m	M30.5 , P0.5	Ø32 x 37.3mm	55g
GMN35020MCN-1	50.0mm	F2.0-16	7°3'x5°5'x9°2'		0.5m	M30.5 , P0.5	Ø32 x 40.0mm	75g
GMT35018MCN	50.0mm	F1.8-Close	8°1'x6°2'x9°9'		0.7m	M30.5 , P0.5	Ø32 x 34.0mm	55g
GM37527MCN	75.0mm	F2.7-Close	4°46'x3°34'x5°58'		1.0m	M30.5 , P0.5	Ø32 x 42.5mm	55g
GMN37525MCN-1	75.0mm	F2.5-16	4°9'x3°7'x6°1'		1.2m	M34.0 , P0.5	Ø36 x 51.0mm	90g
GM310035MCN	100.0mm	F3.5-Close	3°47'x2°51'x4°42'		1.0m	M30.5 , P0.5	Ø32 x 44.2mm	59g
GMN310028MCN-1	100.0mm	F2.8-16	3°7'x2°8'x4°6'		2.0m	M40.5 , P0.5	Ø42 x 70.0mm	140g

## 1Inch Format Lenses

Item No.	F Length	Iris Range	Angle of View (HxVxD)	M.O.D	FilterThread	Dimension (DxL)	Weight
GMG42514C	25mm	F1.4-Close	28°7'x21°7'x36°0'	0.5m	M37.5 , P0.5	Ø40 x 38.6mm	65g
GMG42514MCN	25.0mm	F1.4-Close	28°7'x21°7'x36°0'	0.5m	M34 , P0.5	Ø36.5 x 36.7mm	110g
GMG45018MCN	50.0mm	F1.8-Close	14°5'x10°9'x18°0'	0.7m	M40.5 , P0.5	Ø46 x 42.5mm	150g
GMG47518MCN	75.0mm	F1.8-Close	9°7'x7°3'x12°3'	0.8m	M46 , P0.75	Ø48.0 x 58.5mm	250g

## Manual Zoom Lenses

Item No.	F Length	Iris Range	Angle of View (HxVxD)	M.O.D	FilterThread	Dimension (DxL)	Weight
GMZ16539MSN	6.5-39mm	F1.4-Close	1/3" 40° x 31° - 7° x 5°5'	0.8m	M37.5 , P0.5	Ø44X73mm	125g
GMZ8590056MCN	8.5-90mm	F5.6-16	1/3" 173mmx129mm- 7.9mmx6.2mm	290-135mm	M43.0 , P0.75	Ø54 x 128.0mm	320g
GMZ85900MCN	8.5-90mm	F2.5-Close	1/3" 172mmx128mm - 6.9mmx5.2mm	310-150mm	M48.0 , P0.75	Ø60 x 138mm	450g
GMZ8048010MCN	8-48mm	F1.0-Close	1/2" 43°6'x33°4'x54°92' - 7°7'x5°7'x9°58'	1.0m	M46 , P0.75	Ø58 x 102.4mm	395g
GMZ28551MCN	8.5-51mm	F1.4-Close	1/2" 31°x23° - 5°5'x4°5'	0.8m	M37.5 , P0.5	Ø44X78mm	125g
GMZ28585MCN	8.5-85mm	F1.6-Close	1/2" 41°x31°5' - 4°3'x3°2'	1.2m	M46 , P0.75	Ø52X102.5mm	210g
GMZ11569MCN	11.5-69mm	F1.4-Close	1/2" 31°1'x23°6'x38°3' - 5°3'x4°0'x6°6'	1.0m	M46 , P0.75	Ø58 x 113mm	420g
			2/3" 41°9'x32°0'x51°6' - 7°3'x5°5'x9°0'				
GMZ16100MCN	16-100mm	F1.9-Close	1" 43°6'x33°4' - 7°3'x5°5'	1.1m	M58 , P0.75	Ø62.8 x 123.6mm	620g

\*Specifications are subject to change without prior notice

## Three Motorized Zoom Lenses (Motorized Zoom , Motorized Focus , Motorized Iris)

Item No.	F Length	Iris Range	Angle of View (HxVxD)	M.O.D	FilterThread	Dimension (WxHxL)	Weight
GAZ6060010M	6-60mm	F1.0-Close	1/3" 43°6'x33°4'x53° - 4°6'x3°4'x5°7'	1.2m	M62 , P0.75	80x70x131mm	700g
GAZ656514M	6.5-65mm	F1.4-Close	1/3" 40°5'x31°x52°2' - 4°2'x3°2'x5°2'	1.2m	M43 , P0.75	70x65x105mm	290g
GAZ8048010M	8-48mm	F1.0-Close	1/2" 43°6'x33°4' - 7°7'x5°7'	1.0m	M52 , P0.75	70x60x98mm	500g
GAZ80800M	8-80mm	F1.2-Close	1/2" 43°6'x33°4' - 4°6'x3°4'	1.2m	M62 , P0.75	80x70x130mm	700g
GAZ858516M	8.5-85mm	F1.6-Close	1/2" 41°3'x31°5'x52°4' - 4°2'x3°2'x5°2'	1.2m	M43 , P0.75	70x65x102mm	280g
GAZ65104M	6.5-104mm	F1.4-Close	1/2" 52°4'x40°5' - 3°5'x2°6'	1.5m	M86 , R1.0	125x100x160mm	1500g
GAZ75120M	7.5-120mm	F1.6-Close	1/2" 3°22'x45°35'	1.5m	M72 , R1.0	80x98x143mm	980g
GAZ85136M	8.5-136mm	F1.6-Close	1/2" 43°6'x33°4' - 2°7'x2°2'	1.8m	M58 , P0.75	80x101x159mm	650g
GAZ10220M	10-220mm	F2.2-Close	1/2" 1°74'x34°14'	1.8m	M67 , R0.75	79x72.5x134mm	1150g
GAZ1025018M	10-250mm	F1.8-Close	1/2" 37°3'x27°7' - 1°5'x1°1'	2.5m	M86 , R0.1	110x100x200mm	1500g
GAZ13280M	13-280mm	F2.8-Close	1/2" 1°37'x26°76'	1.8m	M67 , R0.75	80x101x169mm	1150g
GAZ10330M	10-330mm	F1.5-Close	1/2" 1°13'x34°99'	2.9m	M105 , R1.0	122x125x261mm	2900g
GAZ15500M	15-500mm	F4-Close	1/2" 0°747'x23°185'	2.9m	M105 , R1.0	122x125x267mm	2900g
GAZ10550M	10-550mm	F3.8-Close	1/2" 0°69'x34°57'	5m	M95 , R1.0	132x121x299mm	4070g
GAZ15825M	15-825mm	F5.7-Close	1/2" 0°46'x23°48'	5m	M95 , R1.0	132x121x321mm	4070g
GAZ10550-2X	20-1100mm	F7.6-720	1/2" 0°34'x34°57'	5m	M95 , R1.0	132x121x299mm	4070g
GAZ11569M	11.5-69mm	F1.4-Close	2/3" 41°9'x32° - 7°3'x5°5'	1.0m	M52 , P0.75	70x60x105mm	500g
GAZ10100M	10-100mm	F1.4-Close	2/3" 47°5'x36°5' - 5°0'x3°8'	1.2m	M62 , P0.75	80x70x125mm	700g
GAZ95152M	9.5-152mm	F1.8-Close	2/3" 49°7'x38°3' - 3°3'x2°5'	1.0m	M86 , P1.0	125x100x175mm	1500g
GAZ16160M	16-160mm	F2.2-Close	1" 43°6'x33°4' - 4°6'x3°4'	1.1m	M77 , P0.75	120x100x180mm	1500g

## SWIR Lenses (also for InGaAs camera 900-1700nm)

Item No.	F Length	Iris Range	Angle of View (HxVxD)	M.O.D	FilterThread	Dimension (DxL)	Weight
GMA5HR38028MCN-SWIR	8mm	F2.8-22	2/3" 57°9'x45°0'	0.1m	M49 , P0.75	Ø51 x 48.5mm	210g
GMA5HR31218MCN-SWIR	12mm	F1.8-22	2/3" 40°3'x30°8'	0.15m	M49 , P0.75	Ø51 x 59.0mm	200g
GMA5HR31614MCN-SWIR	16mm	F1.4-22	2/3" 30°7'x23°3'	0.2m	M49 , P0.75	Ø51 x 62.5mm	200g
GMA5HR32514MCN-SWIR	25mm	F1.4-22	2/3" 20°0'x15°0'	0.2m	M49 , P0.75	Ø51 x 48.0mm	190g
GMA5HR33514MCN-SWIR	35mm	F1.4-22	2/3" 10°4'x 7°8'	0.25m	M49 , P0.75	Ø51 x 62.0mm	230g
GMTHR46018MCN-SWIR	6mm	F1.8-22	1" 95°1'x78°x7'x104°6'	0.1m	-	Ø54 x 50.3mm	250g
GMTHR48014MCN-1-SWIR	8mm	F1.4-22	1" 79°7'x62°9'x92°6'	0.3m	M55 , P0.75	Ø57 x 58mm	200g
GMTHR412514MCN-1-SWIR	12.5mm	F1.4-22	1" 55°7'x42°7'x67°8'	0.3m	M35.5 , P0.5	Ø40 x 52mm	180g
GMTHR41614MCN-SWIR	16mm	F1.4-22	1" 44°5'x33°8'x54°6'	0.3m	M35.5 , P0.5	Ø40 x 42mm	225g
GMTHR42514MCN-SWIR	25mm	F1.4-22	1" 29°x21°9'x36°1'	0.3m	M35.5 , P0.5	Ø40 x 42.5mm	225g
GMTHR43514MCN-SWIR	35mm	F1.4-22	1" 20°9'x16°0'x26°0°	0.3m	M35.5 , P0.5	Ø40 x 42.5mm	225g
GMG42514MCN-SWIR	25mm	F1.4-Close	1" 28°7'x21°7'x36°0'	0.5m	M34 , P0.5	Ø36.5 x 36.7mm	110g
GMG45018MCN-SWIR	50mm	F1.4-Close	1" 14°5'x10°9'x18°0'	0.7m	M40.5 , P0.5	Ø46 x 42.5mm	150g
GMG47518MCN-SWIR	75mm	F1.4-Close	1" 9°7'x7°3'x12°3'	0.8m	M46 , P0.75	Ø48 x 58.5mm	250g
GM5HR612520MCN-SWIR	12.5 mm	F2-5.6	4/3" 38°6'x31°x90	0.3m	M46 , P0.75	Ø48 x 67mm	230g

\*Specifications are subject to change without prior notice

## LWIR Lenses

Item No.	F Length	Iris Range	Angle of View	Wave Length	Sensor Size	M.O.D	Dimension (DxL)	Weight	Operating Temperature
GLWIR7510	7.5mm	F1.0	71°84'x60°18'	17um	640x512	1m	Ø56.5 x 60.8mm	35g	-40°C - +80°C
GLWIR1910	19mm	F1.0	31°65'x25°56'	17um	640x512	3m	Ø36 x 21.4mm	40g	-40°C - +80°C
GLWIR2510	125mm	F1.0	24°72'x19°88'	17um	640x512	3m	Ø22.5 x 21mm	45g	-40°C - +80°C

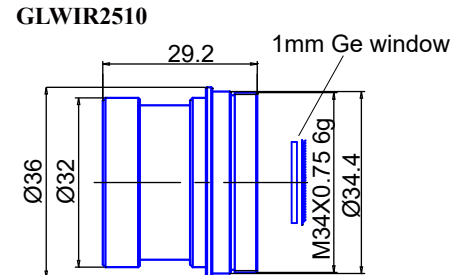
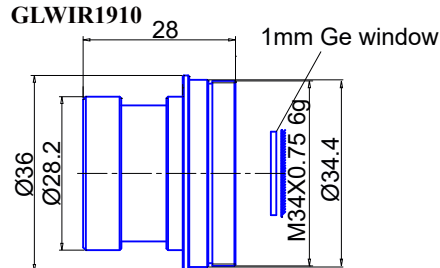
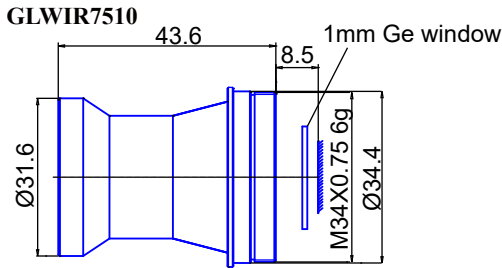

## Fish Eye Lenses

Item No.	F Length	Iris Range	Angle of View	M.O.D	FilterThread	Dimension (DxL)	Weight
GM5HR31814MCN	1.8mm	F1.4-16	185° (Ø5.7mm)	0.15m	-	Ø56.5 x 60.8mm	195g
GM5HR318161MCN	1.8mm	F1.61	185° (Ø5.7mm)	0.15m	-	Ø36 x 21.4mm	50g
GM141228M12	1.2mm	F2.8	192° (Ø4.6mm)	0.15m	-	Ø22.5 x 21mm	15g

## F0.8-F0.95 lenses

Item No.	F Length	Iris Range	Angle of View	M.O.D	FilterThread	Dimension (DxL)	Weight
GMHR62408M42N	24mm	F0.8-16	4/3" 39°3'x30°8'x49°	0.15m	M67, P0.75	Ø74X103mm	900g
GMHR62409MCN	24mm	F0.9-16	4/3" 39°3'x30°8'x49°	0.15m	M67, P0.75	Ø74X105mm	900g
GMY31795MCN	17.0mm	F0.95-16	2/3" 21°3'x16°1'x26°5'	0.42m	M40.5, P0.5	Ø42 x 63.5mm	165g
GMY42595MCN	25.0mm	F0.95-16	1" 28°7'x21°7'x35°5'	0.45m	M40.5, P0.5	Ø42 x 45.5mm	120g
GMV42595MC	25.0mm	F0.95-16	1" 28°6'x21°7'x35°2'	0.4m	M40.5, P0.5	Ø46 x 47.0mm	145g
GMV45095MCN	50.0mm	F0.95-16	1" 14°x11°x18°	0.6m	M62, P0.75	Ø65 x 75mm	470g

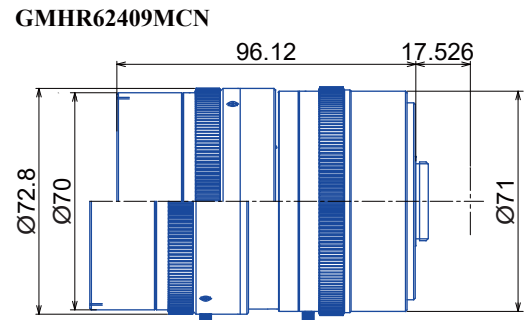
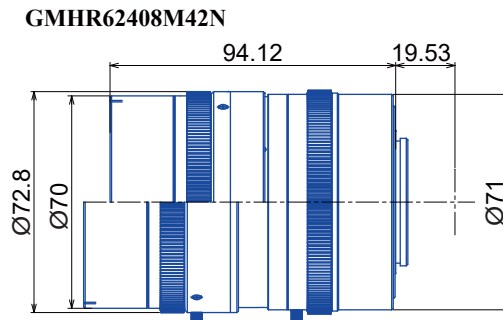
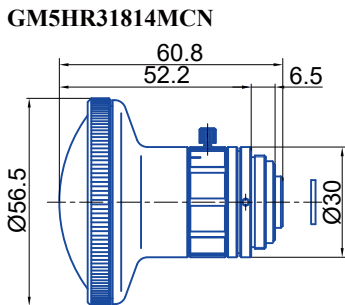

## 3CCD Camera Lenses

Item No.	F Length	Iris Range	Angle of View	M.O.D	Filter Thread	Dimension	Weight
GMZ3D85900MCN	8.5-90mm	F2.5-Close	31°3'x23°5' - 3°2'x2°4'	0.15m	M48.0, P0.75	Ø60 x 129mm	420g
GAZ3D270112M	7-112mm	F1.4-Close	1/2" 49°1'x37°8' - 3°3'x2°5'	1.0m(22mm at Macro)	M86, P0.1	Ø121 x 100 x 176mm	1500g
GAZ3D395152M	9.5-52mm	F1.8-Close	2/3" 49°7'x38°3' - 3°3'x2°5'	1.0m(22mm at Macro)	M86, P0.1	Ø121 x 100 x 176mm	1500g

\*Specifications are subject to change without prior notice



## UV Quarz Glass Lenses

Item No.	F Length	Aperture Ratio	Image Circle	Angle of View at Infinity	Optical Distortion	Filter Size	Mount
GMUV42528C	25mm	2.8-16	16mm	29°7'x22°2'x37°2'	-4.05%	M25.5 , P0.5	C-Mount
GMUV55035C	50.53mm	3.5-16	18mm	20°3'	-0.76%	M55 , P0.75	C-Mount, T-Mount
GMUV57838C-1	77.5mm	3.8-16	18mm	9°45'x7°09'x11°8'	-0.27%	M49 , P0.75	C-Mount, T-Mount
GMUV510540C	105mm	4.0-22	18mm	6°98'x5°24'x8°83'	-0.11%	M49 , P0.75	C-Mount, T-Mount

## Line Sensor Lenses

Item No.	F Length	Iris Range	Sensor Size	M.O.D	Frang Back	Filter Size	Mount
GLSW2528F	25mm	F2.8-22	Ø44mm	150mm		M77xP0.75	F or M58
GLS2828F	28.5mm	F2.8-16	Ø30mm(3CCD)	0.5m	46.5mm in air	M58 x 0.75	F-Mount
GLSW3528F	35mm	F2.8-22	Ø44mm	150mm		M52xP0.75	F or M58
GLS3528F	35mm	F2.8-22	Ø30mm(3CCD)	0.5m	46.5mm in air	M62 x 0.75	F-Mount
GLS5014F	51.55mm	F1.4-16	Ø29mm	0.358m(x0.149)	46.5mm in air	M58 x 0.75	F-Mount
GLSW5028F	50mm	F2.8-22	Ø44mm	300mm		M67xP0.75	F or M58
GLS5028F	52mm	F2.8-16	Ø30mm(3CCD)	0.5m	46.5mm in air	M46 x 0.75	F-Mount
GLS5526F	54.6mm	F2.6-16	Ø44mm	146mm(x0.067)-163.6mm(x0.35) only	46.5mm in air	M67 x 0.75	F-Mount
GLS8556M+ADP	85mm	F5.6-32	Ø58mm	0.8m	-	possible	T
GLS10028F	100mm	F2.8-32	Ø43mm	0.3m	46.5mm in air	M55 x 0.75	F-Mount

GLSW2528F

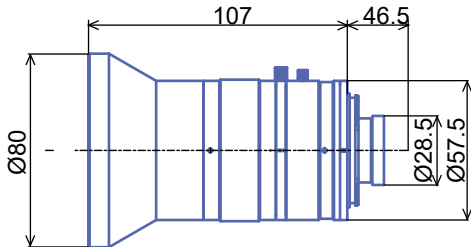

GLSW3528F

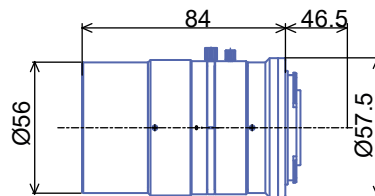

GLSW5028F

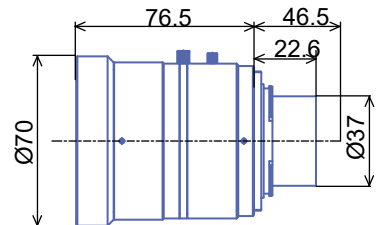

GLS8556M+ADP

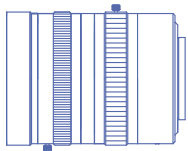

GLS5014F

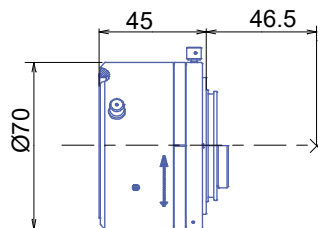

GLS5526F

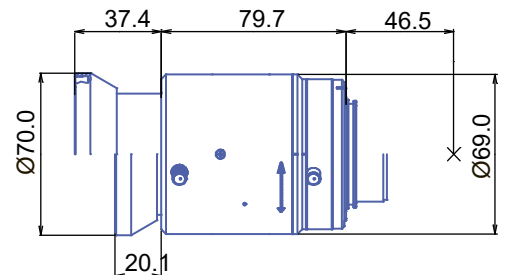

GLS10028F

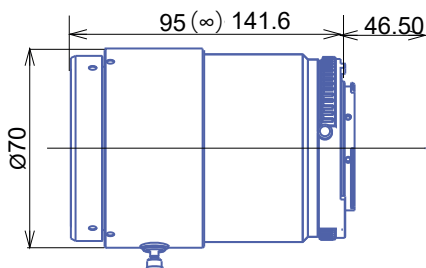

GMZ28585MCN

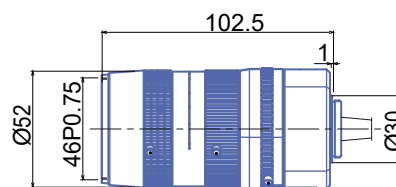

GM5HR612520MCN-SWIR

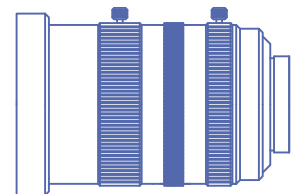

\*Specifications are subject to change without prior notice